



Original Instructions
Warning! Read instructions before using the machine

PVT 220A PVT 390A



Numatic International Ltd, Chard, Somerset, TA20 2GB, UK
Telephone: +44 (0) 1460 68600 Fax: +44 (0) 1460 68458
www.numatic.co.uk © Numatic International Limited.



ProVac

Kit - A1



Kit A1 607301





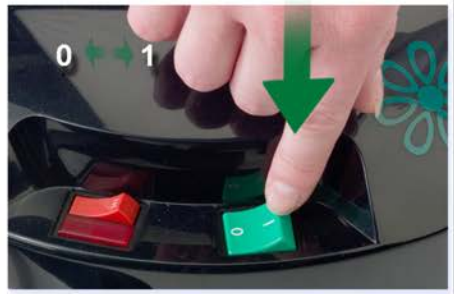

Lo = 60%



Hi = 100%



Lo
Suction
1500mm



Hi
Suction
2500mm



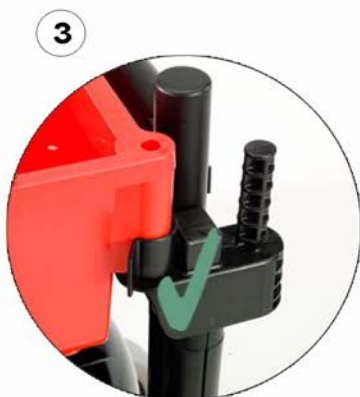

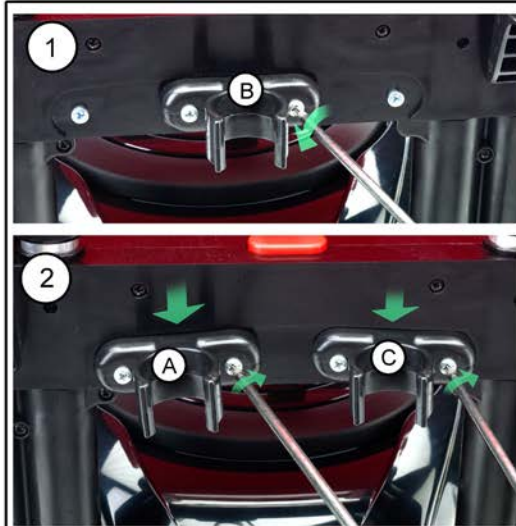
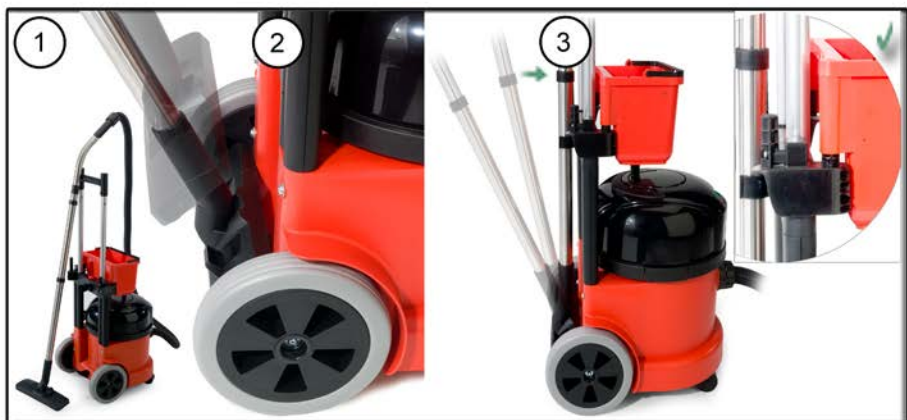



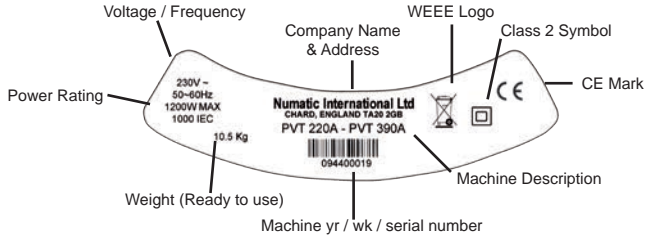

About the machine



WEEE (Waste, Electrical and Electronic Equipment)	Safety Critical Components
<p>Vacuum cleaner, accessories and packaging should be sorted for environmental-friendly recycling.</p> <p>Only for EU countries: Do not dispose of Vacuum cleaner into household waste! According to the European Directive 2002/96/EC on waste electrical and electronic equipment and its incorporation into national law. Vacuum cleaners that are no longer suitable for use must be separately collected and sent for recovery in an environmental-friendly manner.</p> 	<p>Mains lead HO5V2V2-F 2 x 1.00mm²</p> <p>Filter Bag NVM-1CH >pp< construction 99.6% @ 0.3µm NVM-2BH >pp< construction 99.6% @ 0.3µm</p> <p>Filter Tritex NVM 604165 >pp< construction 96.0% @ 0.3µm Microtex NVM 604311 >pp< construction 99.6% @ 0.3µm Microfresh NVM 604170 >pp< construction 98.4% @ 0.3µm</p>

PPE

(Personal Protective Equipment) that may be required for certain operations.

NOTE:

A risk assessment should be conducted to determine which PPE should be worn.



Ear Protection



Safety Footwear



Head Protection



Safety Gloves



Dust / Allergens Protection



Eye Protection



Protective Clothing



Caution Floorsign



Do not place more than 2.5 Kg (MAX weight) into each caddy.

Do not place liquid in the caddy, this is a dry use machine only.

DATA	Motor	Airflow	Suction
	1200W 600W	42 L/ Sec	2500mm 1500mm
Size Range	Capacity	Cleaning range	Weight
220 390	9L 15L	31.8m	10.5Kg 11.0Kg
Size Range	Size	Sound Pressure	Protection Class
220 390	355x355x615 mm 355x355x665 mm	67.5 dB - 65.2 dB (A) (IEC 60704-2-1) Uncertainty 0.2 dB	Class II

Information for DRY USE Vacuum Cleaners

WARNING:

Read the instruction manual before using the machine.

Operators shall be adequately instructed on the use of their machine.

As with all electrical equipment, care and attention must be exercised at all times during use, in addition to ensuring that routine and preventative maintenance is carried out periodically to ensure safe operation.

Failure to carry out maintenance as necessary, including the replacement of parts to the correct standard could render this equipment unsafe and the manufacturer can accept no responsibility in this respect. Maintenance should only be carried out by a qualified person.

This machine is for DRY USE only and must not be stored outside or used in wet conditions.

The machine shall be disconnected from the mains by removing the plug from the supply socket during cleaning or maintenance and when replacing parts or converting the machine to another function.

The machine is not to be used by children or persons with reduced physical, sensory or mental capabilities, or lack of experience or knowledge, unless they have been given supervision or instruction.

This appliance is intended to be cleaned and maintained by an adult.

Children being supervised are not to play with the machine.

This machine is not a toy.

CAUTION:

This machine is not suitable for picking up hazardous or explosive dust. Contact your local distributor if you require a machine capable of performing these tasks.

Ensure that the filtration system fitted to the machine is suitable for the material being collected.

This vacuum cleaner is intended for indoor use in the collection of dry materials.

This machine should be stored indoors only.

NOTE:

This machine is also suitable for commercial dry use, for example in hotels, schools, hospitals, factories, shops and offices for other than normal housekeeping purposes. This product complies with the requirements of IEC60335-2.69.

This vacuum cleaner is fitted with a thermal protection device. If the vacuum cleaner stops working, remove the plug from the wall before investigating where the fault lies.

If the vacuum cleaner has a blockage, switch off, remove the plug from the wall, inspect the floor tool, tubes and hose for debris. If the floor tool, tubes and hose are clear, replace the dust bag and clean the filter.

The vacuum cleaner should be inspected after use for damage.

Not suitable for the collection of biological hazards, hazardous, or explosive dusts .

The vacuum cleaner should be stored in a dry place.

DO:

- Keep your machine clean including hoses and tubes.
- Change dust bag frequently.
- Keep filters clean.
- Keep diffuser filter (where fitted) clean.
- Use filter bags, they will enhance performance and help keep machine clean.
- Use a Numatic Original filter bag under fine dust conditions.
- Keep hoses and tubes clear.
- Replace any worn or damaged parts immediately.
- Only use the socket outlet on the machine for purposes specified in the instructions.
- Only use the brushes provided with the machine. The use of other brushes may impair safety.
- Regularly examine the power cord. If damage is found such as cracking or ageing the power cord must be replaced by a qualified person.
- Only replace the power cord with the correct Numatic approved replacement part.

DON'T:

- Unreel the cable with one pull or pull on the cable to unplug the machine from the power supply.
- Use to suck up hot ashes or lighted cigarette ends.
- Use steam cleaners or pressure washers to clean the machine or use in the rain.
- Immerse in water for cleaning.
- Attempt machine maintenance or cleaning unless the power supply plug has been removed from the supply outlet.

Do not use in wet environments or to collect wet materials.

Do not place liquid in the caddy, this is a dry use machine only.

Do not place more than 2.5 Kg (MAX weight) into each caddy.

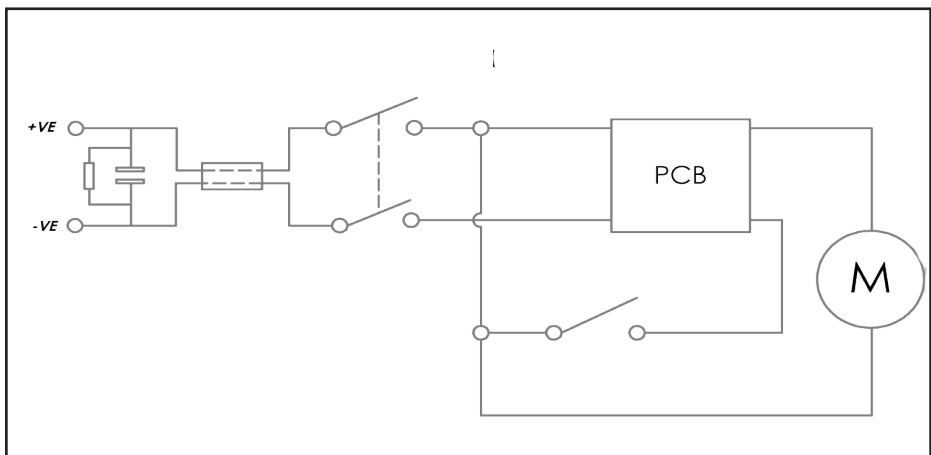

Numatic International Warranty

Numatic International Limited warrant to the original purchaser that its products are free of defects in both material or workmanship for the period shown below:-

Homecare and Cleancare Vacuum cleaners.....	2 Years
Rotary Floor Machines.....	2 Years
Twintec Auto Scrubber Dryer.....	1 Year
Vario Ride-On Scrubber Dryer.....	1 Year / 1500 hours
Mopping, Compacts, Combi and Servocare Products.....	1 Year
Individual Accessories and Spare Parts.....	6 Months

Note: This warranty expressly excludes consumable parts such as carbon brushes, floor brushes, mops, batteries etc, that are considered replaceable from time to time during the normal working life of the machine.

- A. The warranty period commences from the date the goods are purchased.
- B. All warranty claims must be processed through the Dealer from whom the equipment was purchased. The Dealer will co-operate with the purchaser throughout the warranty claims procedure and will arrange any necessary repairs using genuine Numatic parts.
- C. If the original Dealer is no longer able to fulfil his obligations please contact Numatic International Limited with full details of the claim and proof of purchase so that this may be processed without delay.
- D. Any warranty claim can only relate to the specific part that is proven to be at fault and for which a replacement will be supplied but cannot be extended to constitute a claim against the complete machine.
- E. Numatic International will supply the Dealer with any warranty parts required, subject to the claim being validated, after return of the faulty items in accordance with Numatic International Limited's General Conditions of Sale.
- F. Claims will not be accepted if they are the result of fair wear and tear, misuse or abuse of any kind.
- G. No replacement will be given unless the appropriate evidence of the validity of the claim has been provided to the satisfaction of Numatic International Limited.
- H. Numatic International Limited reserve the right to charge for any unnecessary work carried out as a result of an invalid claim.
- I. No variation to this warranty may be made or implied by any member of Numatic International Limited or its Dealers unless such variation is in writing and authorised by the Company



Numatic International Limited, Chard, Somerset, TA20 2GB
Telephone: 01460 68600 Fax: 01460 68456
© Numatic International Limited



EU DECLARATION OF CONFORMITY

We hereby declare that the following equipment fulfils all the relevant provisions of:

- Machinery Directive 2006/42/EC
- EMC Directive 2004/108/EC
- Low Voltage Directive 2006/95/EC

Machine Description: Vacuum Cleaner
Type: PVR, NSR, NST, PVT series
Manufactured by: Numatic International Limited

This equipment has been designed and manufactured in accordance with the following harmonised European standards:

- IEC60335-1:2001 +A1:2004 +A2:2006**
- IEC60335-2-2:2002 +A1:2004 +A2:2006**

- EN 55014-1 2001 +A1 2001, +A2 2002**
- EN 55014-2 1997 + A1 2001 (Cat II)**
- EN 50366 2003 + A1 2006**

A technical construction file for this equipment is retained at the manufacturer's address.

Signed:  Date: 12/07/10

Name: Allyn Boyes Position: Technical Manager



Numatic International Limited,
Chard, Somerset.
TA20 2GB

www.numatic.co.uk



607222

Blue
Caddy
Kit

NST / PVT Extra Caddy Kit



ProVac Series Spare Parts

*Use genuine Numatic Spare Parts.
Contact your local service engineer.*



	583210	PVR / PVT Head
	604165	Tritex Filter
	500972	220 PVT Drum
	500966	390 PVT Drum

	204111	220 / 390 Castor
	204104 237120	220 / 390 Rear Wheel 220 / 390 Wheel Hub
	237121	Floor Tool Peg
	237154	Wand Clip
	237155	Caddy Clip
	607233	Red Swing Caddy
Reorder- 220 Drum HepaFlo Bags Pack of 10 NVM - 1CH 604015		Reorder- 390 Drum HepaFlo Bags Pack of 10 NVM - 2BH 604016