

RBV 130 Latitude

Numatic Lithium-Ion Battery Powered

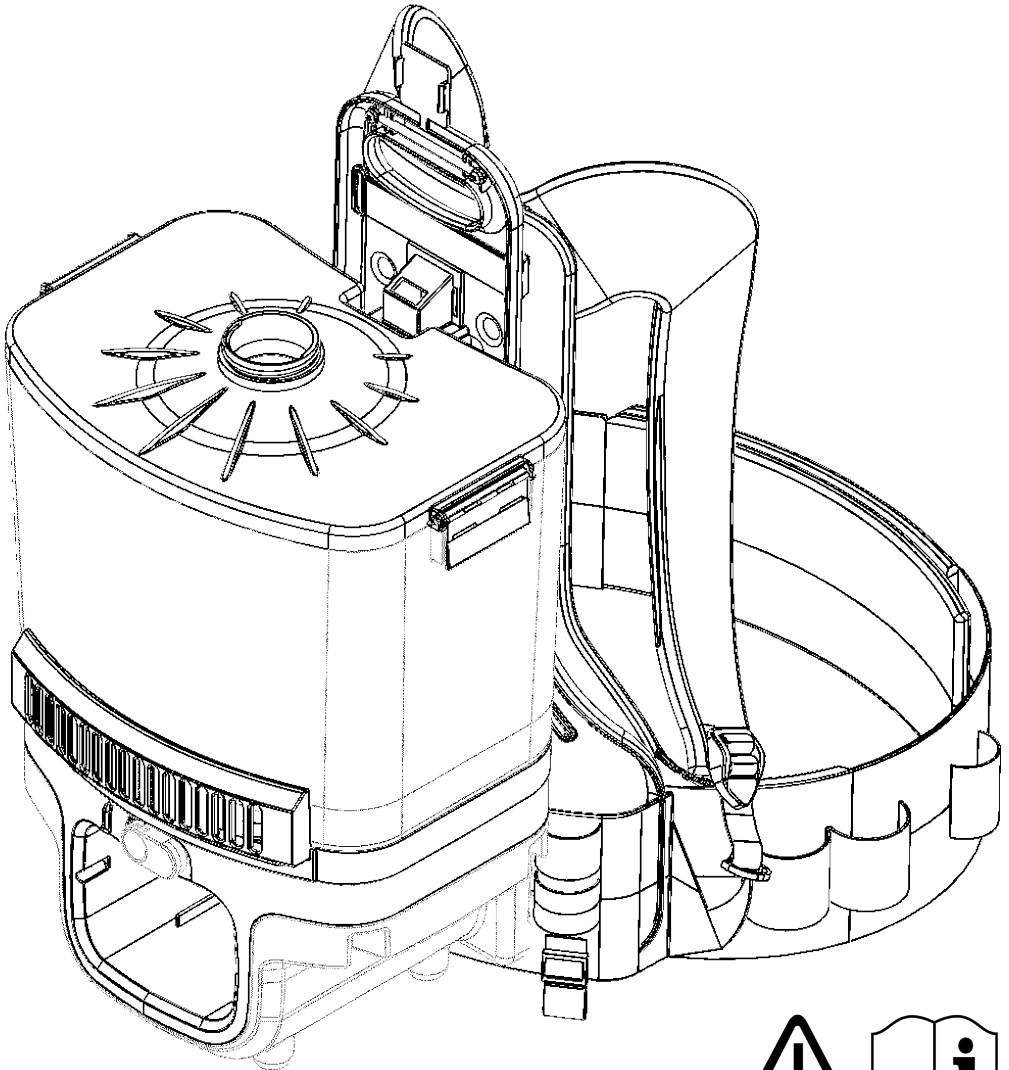

Original Instructions -
Warning! Read instructions before using the machine.



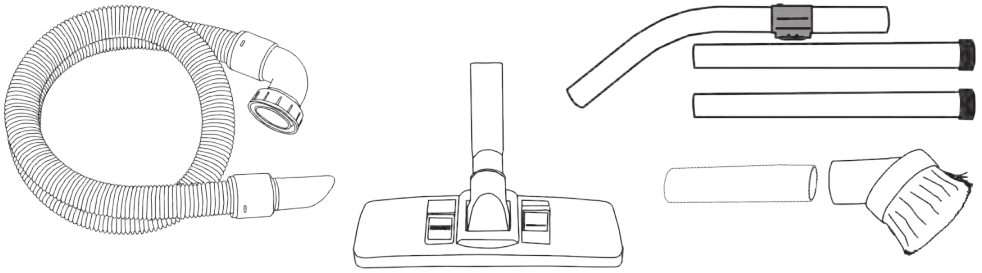

Assembly

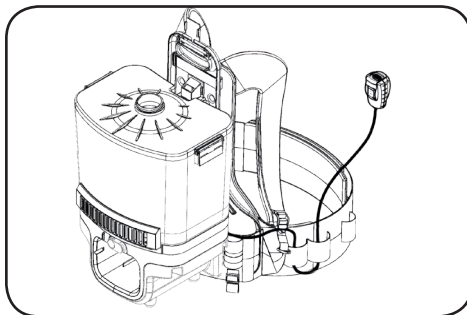
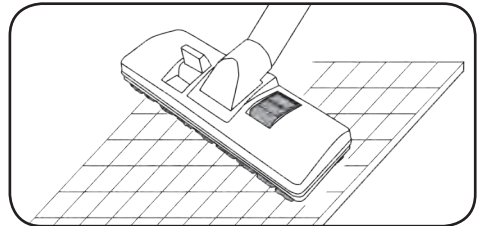
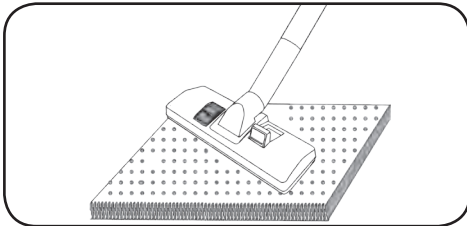
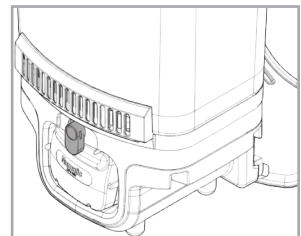
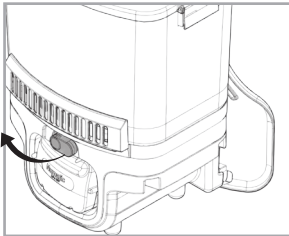
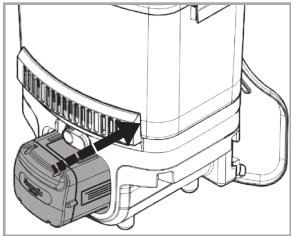
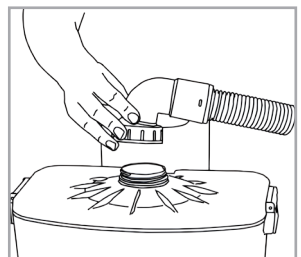
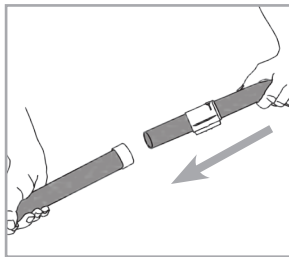
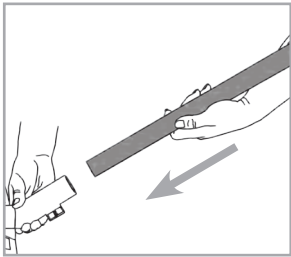

Note.
 The Remote switch cable should pass through the belt loop, making it easier to find when wearing the machine.

Using your machine

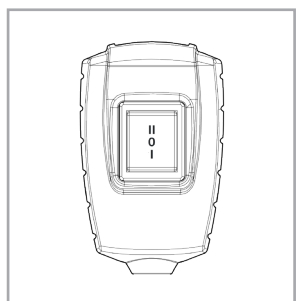
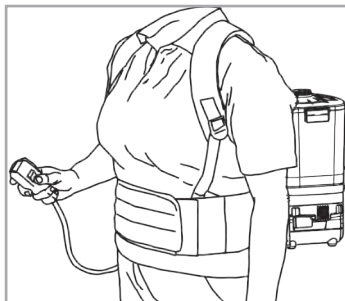
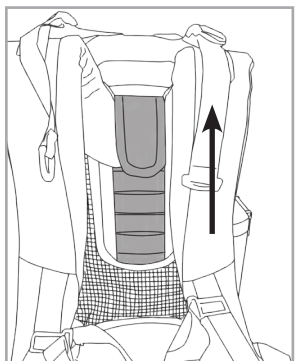
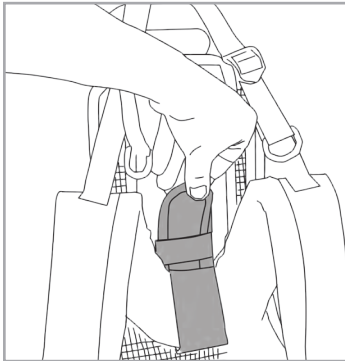
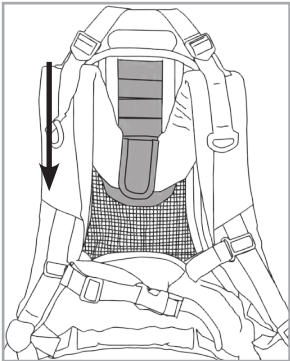
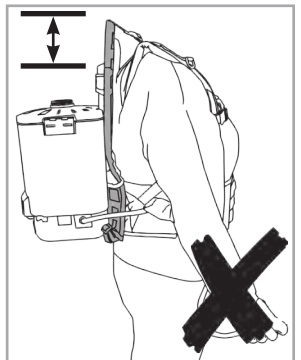
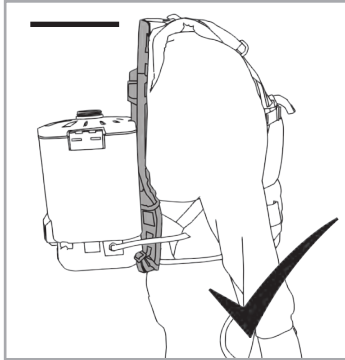
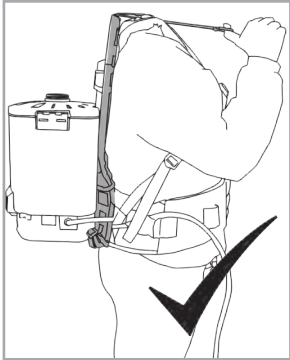
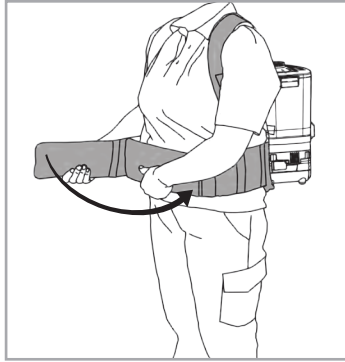
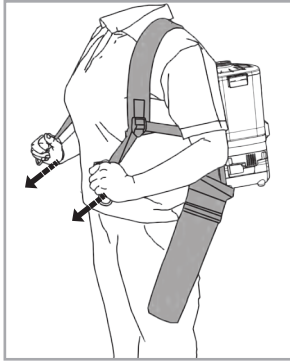

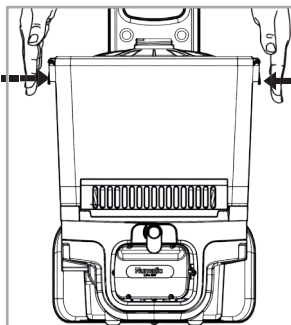
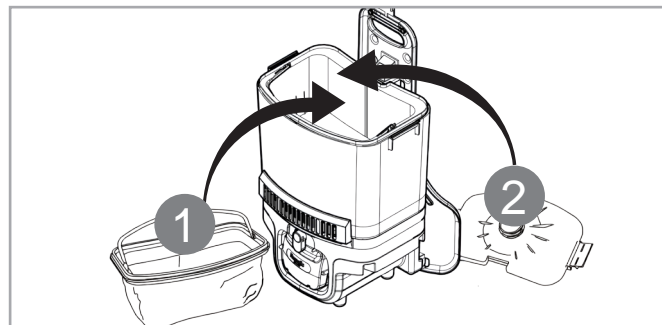
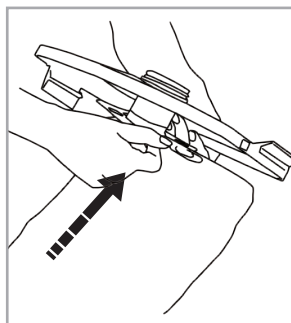
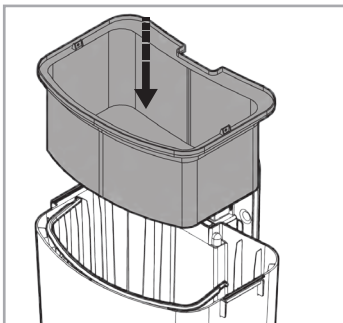
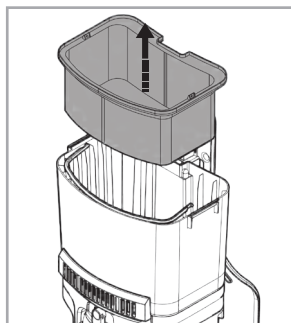
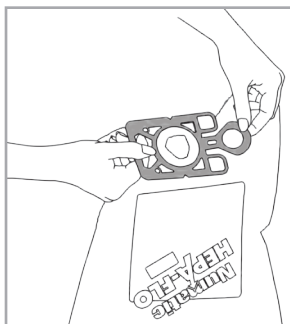
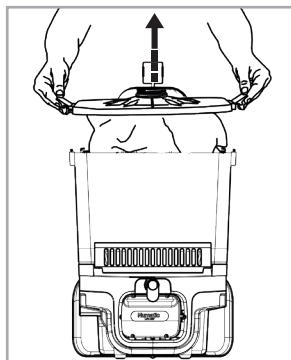
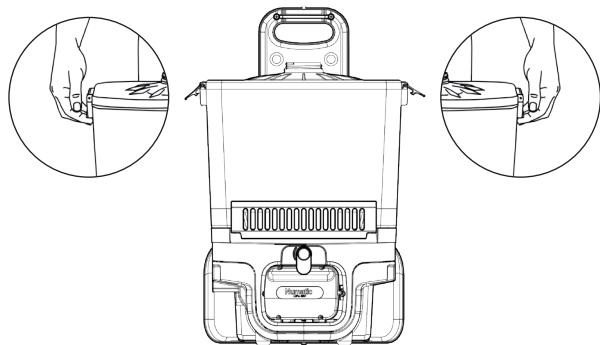

Charging the machine

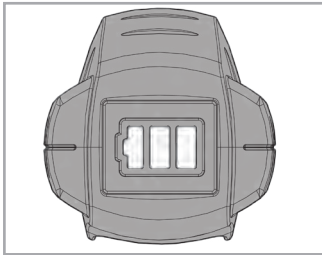

Cleaning Time

Hi = 40 mins

Lo = 60 mins

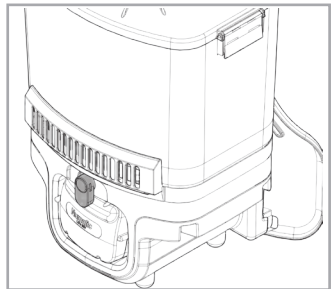
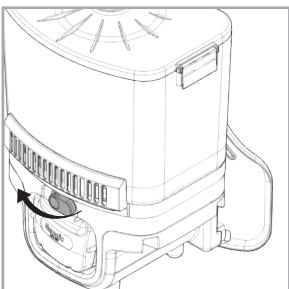
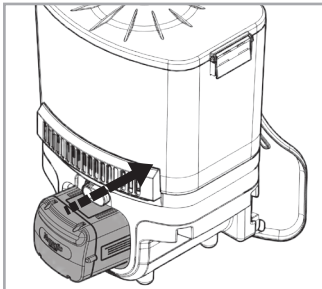
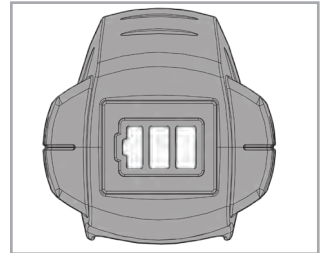
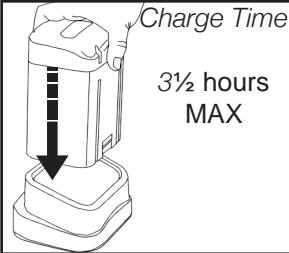
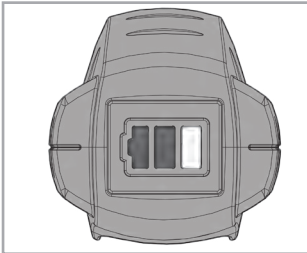
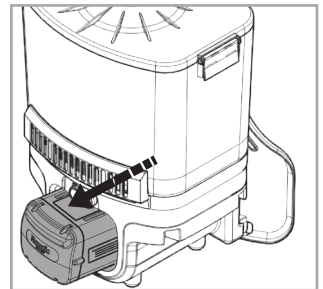
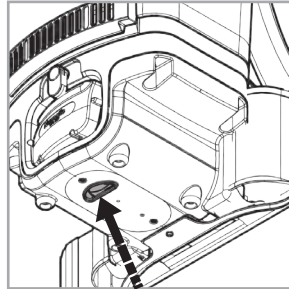
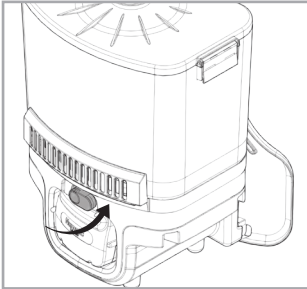
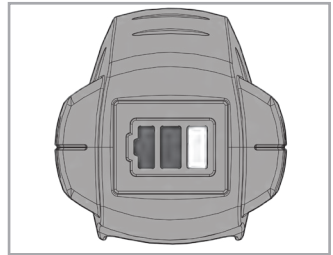

Data

Power	Motor	AirFlow	Suction	Size	Run Time
36V (DC)	250W	20 L/s	1000 mm H ² O	360x250x550 mm	Hi = 40 Mins Lo = 60 mins
Weight	Sound Pressure	Capacity	Charge Time	Dust Bag	
8.7 KG	65 dB (A) Uncertainty 0.5 dB	6 Ltr	3.5 hrs	NVM-1AH	

- 1 Voltage
- 2 Frequency
- 3 Rated Input Power
- 4 Weight (ready to work)
- 5 Company Name & Address
- 6 Model
- 7 Machine yr/wk Serial number
- 8 CE Mark
- 9 WEEE Symbol

Numatic
International Ltd.
CHARD, ENGLAND, TA202GB

RSB 140

1 36V DC

2 300W MAX

3 250W IEC

4 8.67 Kg

5

6

9

8

7

CE

094300118

Rating Label

PPE (personal protective equipment) That may be required for certain operations.

				
Ear Protection	Safety Footwear	Head Protection	Safety Gloves	
				
Eye Protection	Protective Clothing	Dust / Allergens Protection	Hi Viz Jacket	Caution Floor Sign

Note: A risk assessment should be conducted to determine which PPE should be worn.

Failure to rectify the problem or in the event of a breakdown contact your NaceCare dealer or the NaceCare Technical helpline

Daily

- Keep the machine clean, including hoses and tubes.
- Ensure the bag and filter are fitted.
- Regularly examine the charger.
- Check dust bag frequently.
- Check filters are clean.

Weekly - as daily and:-

- Check for any worn or damaged parts and replace immediately.
- Do not steam clean or pressure wash.

Batteries

- Always recharge the batteries after use.

Safety Critical Components

- Multi-Regional Charger (100-240V ~ 50/60 Hz)
- Lithium- Ion Battery 5.2Ah



WARNING!

Read the instruction manual before using the machine.

Operators shall be adequately instructed on the use of these machines, as with all electrical equipment, care and attention must be exercised at all times during use, you must also make certain that routine and preventative maintenance is carried out periodically to ensure safe operation.

Failure to carry out maintenance as necessary, including the replacement of parts to the correct standard could render this equipment unsafe and the manufacturer can accept no responsibility in this respect.

This machine is for DRY USE only.

You must remove the battery from the machine **BEFORE** cleaning or maintenance and when replacing parts or converting the machine to another function.

This appliance is intended to be assembled, cleaned and maintained by an adult.

This machine is not suitable for the collection of biological hazards, hazardous or explosive dusts.

Contact your local distributor if you require a machine capable of performing these tasks.

This machine is not intended for use by persons (including children) with reduced physical, sensory or mental capabilities, or lack of experience and knowledge.

Children should be supervised to ensure that they do not play with the appliance.

This machine is not a toy; children shall not play with this machine.

CAUTION

This machine must not be stored outside, or used in wet environments, or to collect wet materials.

The vacuum cleaner should be stored in a dry place and is for indoor use only.

You must ensure that the filtration system fitted to the machine is suitable for the material being collected.

NOTES

The primary use for this machine is commercial, for example in hotels, schools, hospitals, factories, shops and offices.

This product complies with the requirements of clause 20 of EN/IEC 60335-2-69 Stability and Mechanical Hazards.

This vacuum cleaner is fitted with a thermal protection device.

If the vacuum cleaner has a blockage, remove the battery and inspect the floor tool, tubes and hose for debris.

If the floor tool, tubes and hose are clear, replace the dust bag and clean the filter.

The vacuum cleaner should be inspected after use for damage.

Not suitable for the collection of biological hazards, hazardous, or explosive dusts .

The vacuum cleaner should be stored in a dry place.

DO

- Keep your machine clean including hoses and tubes.
- Change dust bag frequently.
- Keep filters clean.
- Keep diffuser filter (where fitted) clean.
- Use filter bags, they will enhance performance and help keep machine clean.
- Use a Numatic Original filter bag under fine dust conditions.
- Keep hoses and tubes clear.
- Replace any worn or damaged parts immediately.
- Only use the socket outlet on the machine for purposes specified in the instructions.
- Only use the brushes provided with the machine. The use of other brushes may impair safety.
- Regularly examine the power cord. If damage is found such as cracking or ageing the power cord must be replaced by a qualified person.
- Only replace the power cord with the correct Numatic approved replacement part.

DO NOT

- Pull on the cable to unplug the machine from the power supply.
- Use to suck up hot ashes or lighted cigarette ends.
- Use steam cleaners or pressure washers to clean the machine or use in the rain.
- Immerse in water for cleaning.
- Attempt machine maintenance or cleaning unless battery has been removed from the machine.
- Do not use in wet environments or to collect wet materials.

Read all the warnings before using the battery.

- *The battery is equipped with electronic thermal protection, refer to the Temperature Range Table below for recommended operating conditions.*
- *Do not store batteries along with metal objects due to risk of short circuit.*
- *This cleaner uses Numatic Lithium-Ion batteries. Used batteries should be disposed of safely and placed in a sealed plastic bag and then handled according to all locally approved precautions and environmental regulations.*
- *Do not crush.*
- *Do not dismantle.*
- *Do not heat or incinerate the batteries.*
- *Do not short-circuit the batteries.*
- *Do not immerse in any liquid.*
- *Do not charge below 0°C.*
- *Do not charge damaged batteries.*
- *Use only original NUMATIC batteries, when replacement batteries are required.*
- *If the batteries are leaking, return batteries to a disposal plant or a similar local facility.*
- *The batteries must be removed from the appliance before the appliance is scrapped.*
- *The battery is to be disposed of safely and in accordance with all locally approved precautions and environmental regulations.*

Temperature Range Table

Charging	0°C~40°C
Discharging	0°C~60°C
Storage	
Optimum	Below 20°C
Limit	Below 55°C

If the battery is found to be faulty at any time, contact NaceCare, or your supplier for information on disposal.

Lithium-Ion Battery Warranty

Numatic International will guarantee your Numatic Lithium-Ion battery for 550 recharging cycles, providing the cycles have been carried out to the manufacturer's specifications and requirements.

Failure to use the correct Numatic charger will void your warranty.

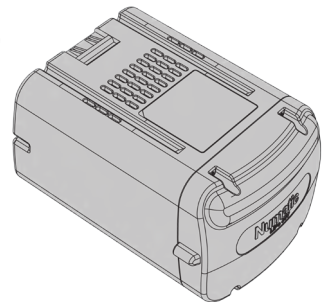

Care and Disposal of Lithium-Ion Batteries

Defective Batteries

ATTENTION

Please follow all safety guidelines set out.

A defective battery should not be stored inside buildings on any account.

1. If a customer wishes to return a battery to a supplier, then collection of the battery must be arranged by the supplier, however, **Faulty batteries must not be returned through the postal system or by courier.**
2. If on return to a supplier, OR at a customer base, a suspected defective battery shows any signs of impact damage, distortion, blistering, loose parts or leakage then on no account should it be offered for condition checking. It must be considered defective and the procedures described from item 8 below should be followed.
3. If, on return to a supplier, OR at a customer base, a suspected defective battery, that shows No signs of impact damage, distortion, blistering, loose parts or leakage, may be offered for condition checking with an appropriate battery condition checking device operated by a competent person.
4. If checking shows the battery to be defective then the procedures described from item 8 below should be followed.
5. If on checking the battery is found to be operational then a single recharge cycle under observation can be attempted with the appropriate Numatic charger.
6. If the battery recharges correctly on this single recharge cycle then it can be deemed a good battery.
7. If the battery fails to recharge correctly on this single recharge cycle then it must be deemed a defective battery and the procedures described from item 8 below should be followed.
8. **On no account must any further attempt to recharge be made.**
9. **A defective battery should not be stored inside buildings on any account.**
10. The defective battery should be discharged by placing it in a container of salt water located in a well - ventilated area. This container should contain 25 litres minimum of saline water at a concentration of 15gr common salt / litre of water. The container should have a closed locked lid but should not be sealed. The battery should be left fully immersed in the water to a depth of at least 100mm for at least 2 weeks. The water should be disposed of as hazardous waste when the discharge is complete.
11. The defective discharged battery can then be stored in a locked battery waste container which should be plastic or plastic lined and placed away from buildings and clearly signed as a defective battery container with appropriate warnings.
12. The batteries should then be sent for waste disposal according with your country's waste regulations.

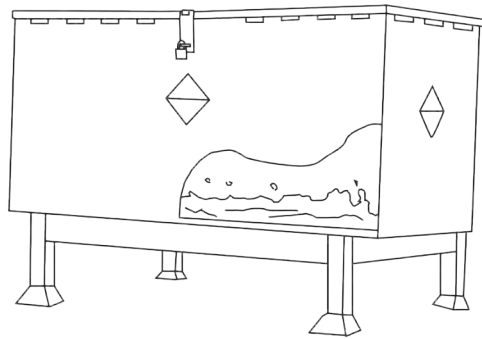

An example of a waste battery storage bin, keep well away from buildings.

ATTENTION

Please follow all safety guidelines set out.

Good batteries should be stored in a protected area away from sources of direct heat and sunlight and should be kept dry.

The temperature should not exceed 55 °C but preferably not be above 20 °C to maintain good battery performance.

Storage area should be of low humidity, non dusty and non corrosive atmosphere.

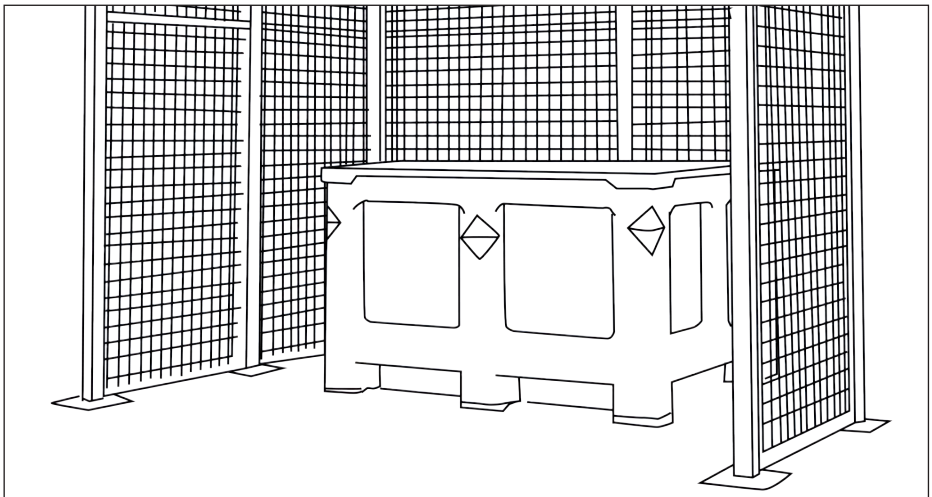

An example of a well protected area with a cage to protect against accidental impact damage and with the batteries stored in a protective container to protect from heat, impact and accidental spillage of liquids.

Care when handling / moving with forklift trucks or pallet trucks is needed at all times to avoid any physical damage to the batteries.

If a good battery at any time is mishandled or subjected to any conditions that may damage it, as described in the battery Instruction manual supplied, it must then be considered as defective and procedures followed from Item 2 of this document overleaf (Page 9).

Read all these warnings before using the charger.

- *CAUTION! Charge only Numatic Lithium-Ion batteries, other types of batteries may burst causing personal injury and damage.*
- *Check the mains cord regularly for any sign of damage.*
- *Do not use damaged devices.*
- *If the mains cord of the charger is damaged, it must be replaced by an original NUMATIC INTERNATIONAL cord available from the manufacturer or service agent.*
- *Protect the charger against moisture and store it in a dry place.*
- *Do not use the charger if it is wet.*
- *Do not charge below 0°C.*
- *The mains voltage available must correspond to the voltage stated on the rating plate of the charger.*
- *Do not operate charger in explosive environment.*
- *Do not carry the charger by holding the mains cord.*
- *Do not handle the electrical cord or plug, with wet hands.*
- *Do not unplug by pulling on cord. To unplug, grasp the plug, not the cord.*
- *Do not cover the charger.*
- *Do not open the charger. Repairs shall be done only by authorised personnel.*
- *Do not charge damaged batteries.*
- *Do only charge dry batteries.*
- *Do not charge non-rechargeable batteries in this charger.*
- *The appliance is not intended for use by children or infirmed persons without supervision.*

Warning: *The battery included in this product must only be charged by the Numatic Charger and docking system supplied with the product and in NO circumstances should an alternative non Numatic charger be used as there is risk severe damage and fire could result.*

Instructions for Use - Charging Batteries

The charger is intended for use only on flat surfaces, place horizontally on floor or work surface.

The charger is intended for use with the detachable power cord supplied, the power unit is capable of operating at different voltages without user adjustment.

If the charger is damaged or does not charge anymore, please return to service centre.

Charging Procedure:

1. *Ensure the battery is fully inserted into the charger.*
2. *Fit the mains power cord to charger and suitable power supply.*
3. *Please Note: If the battery is above its optimum charging temperature (due to ambient temperature or it if was recently discharged) the charger LED will illuminate on/off RED for a maximum of 40 minutes whilst the battery temperature falls to an acceptable level for charging to begin.*
4. *The LED should show RED to indicate charging.*
5. *Once fully charged the LED will show GREEN.*
6. *If power is supplied to the charger with no battery fitted the LED will show GREEN to indicate STAND-BY status.*

Hazards

Health Hazards (Acute & Chronic).

The chemicals used in the battery are in a sealed container.

Risk of exposure only occurs if the battery is abused or damaged.

Contact of electrolyte and lithium with skin and eyes should be avoided.

Signs & Symptoms of Exposure.

A damaged or leaking battery can cause chemical burns upon contact.

If exposed to any of the Chemicals mentioned in the Hazards section please follow the procedures below:

Eyes.

Flush eyes with plenty of water for at least 15 minutes, occasionally lifting the upper and lower eyelid. Seek medical attention.

Skin.

Remove contaminated clothing and rinse skin with plenty of water or shower for 15 minutes. Seek medical attention.

Inhalation.

Vacate from site of exposure to fresh air immediately. Use oxygen if available.

Ingestion.

Give at least two glasses of milk or water. Induce vomiting unless patient is unconscious. Seek medical attention.

Note:

Inhalation, skin contact and eye contact are possible if the battery is damaged. Exposure to internal contents, the corrosive fumes will be very irritating to skin, eyes and mucous membranes.

Overexposure can cause symptoms of non-fibroid lung injury and membrane irritation.

Good Batteries... Good Chargers...
Good Care will ensure Good Results.

Replacement parts

Filter

604168	TriTex Filter
--------	---------------

HepaFlo Dust Bags

604011	NVM-1AH Dust Bags (Pack of 10)
--------	--------------------------------

902440	Lithium-Ion Battery
--------	---------------------

604500	Charger Dock UK
--------	-----------------

HepaFlo Dust Bags

904011 HepaFlo Dust Bags (Pack of 10) NVM-1AH

For best performance make sure you use genuine Numatic bags





EU DECLARATION OF CONFORMITY

We hereby declare under our sole responsibility that the following equipment fulfils all the relevant provisions of the following EU Directives

Machinery Directive 2006/42/EC
EMC Directive 2014/30/EU
RoHS Directive 2011/65/EU

Machine Description: Vacuum Cleaner
Machine Type: RSB, NBV, PBT Series.

Relevant standards upon which conformity is declared include:

EN 60335-1: 2012 + AC:2014 + A11:2014
EN 60335-2-69: 2012
EN 55014-1: 2006 + A1:2009 + A2:2011
EN 55014-2: 1997 +A1:2001 + A2:2008
EN 62233: 2008

A technical construction file for this equipment is retained at the manufacturer's address under the authorisation of the following signatory:

Name: Allyn Boyes Position: Development Manager

Signed

Date

25/7/17



Numatic International Ltd
Chard Somerset
TA20 2GB
www.numatic.co.uk

GB

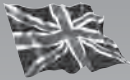
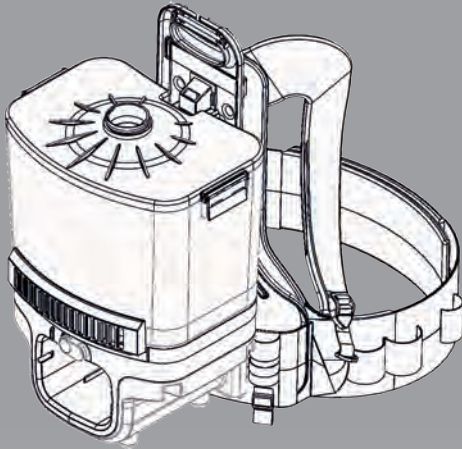

Numatic International Limited.
Chard, Somerset TA20 2GB ENGLAND
Tel.: 01460 68600 www.numatic.co.uk



Numatic International GmbH. Fränkische Straße 15–19
D-30455 Hannover, DEUTSCHLAND
Tel.: 05 11 98 42 16 0 www.numatic.de

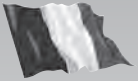

Numatic International SAS. 13 / 17 rue du Valengelier
77500 CHELLES, FRANCE
Tel: 01 64 72 61 61 www.numatic.fr



BeNeLux Distribution, Numatic International BV
Postbus 101, 2400 AC Alphen aan den Rijn, NEDERLAND
Tel: 0172 467 999 www.numatic.nl



Numatic International (Pty.) Ltd.
16th & Pharmaceutical Roads, Midrand, Gauteng,
SOUTH AFRICA 1685
Tel: 0861 686 284 www.numatic.co.za



Numatic International Schweiz AG.
Sihlbruggstrasse 142, 6340 Baar. SCHWEIZ
Tel: 0041 (0) 41 76 80 76 - 0 www.numatic.ch



Numatic International ULDA. Rua da Boa Viagem, 177
4470 - 210 Moreira Maia PORTUGAL
Tel: +351 220 047 700 www.numatic.pt

Specification subject to change without prior notice
www.numatic.co.uk © Numatic International Limited